

# AC-DC POWER SUPPLIES

## UNIVERSAL INPUT, 65 WATT

MEDICAL APPLICATIONS, 2" × 3.5" PACKAGE  
MUI65 DUAL AND TRIPLE OUTPUT



### FEATURES

- 0.15 Watt Low Standby Power Consumption
- Ultra Low Cross Regulation Under 1.5%
- Universal Input Voltage Range 85 - 264 Vac, 47 - 63 Hz
- Built-in Class B EMI Filter
- Output Voltage Adjustable (Output 1 Only)
- 4000 Vac Input to Output 2MOPP Insulation
- Protection Type Class I and Class II
- Low Leakage Current Under 75  $\mu$ A
- Operating Altitude 5000M
- 5 Year Warranty
- Safety Approvals: ANSI/AAMI ES60601-1, EN60601-1 and IEC60601-1 3<sup>rd</sup> Edition
- CE Marked: IEC60601-1-2 ED4.0
- Compliant to RoHS II & Reach
- Dimensions: 2" × 3.5" (50.8 mm × 88.9 mm)

### SELECTION GUIDE All specifications are typical at 230Vac input, full load and 25°C, unless otherwise noted.

Input Voltage Range Vdc	Output 1			Output 2			Output3		Max. Output Power W	Efficiency %	Model Number*
	Voltage Vdc	Current (Normal) A	Max. Current A	Voltage Vdc	Current (Normal) A	Max. Current A	Voltage Vdc	Max. Current A			
85 - 264	5	6	10	3.3	6	8			50	88.5	MUI65-5S33SB
85 - 264	12	3	5.42	5	6	8			65	90	MUI65-1212S5SB
85 - 264	12	3	5.42	3.3	6	8			65	89.5	MUI65-12S33SB
85 - 264	15	2.4	4.34	5	6	8			65	90.5	MUI65-15S5SB
85 - 264	24	1.5	2.71	5	6	8			65	89	MUI65-24S5SB
85 - 264	28	1.25	2.33	5	6	8			65	88	MUI65-28S5SB
85 - 264	5	6	10	3.3	6	8	-5	0.6	50	88	MUI65-5S-33B
85 - 264	5	6	10	3.3	6	8	12	0.6	50	88	MUI65-5S33S12SB
85 - 264	5	6	10	3.3	6	8	-12	0.6	50	88	MUI65-5S33SN12SB
85 - 264	12	3	5.42	5	6	8	-5	0.6	65	89.5	MUI65-12S-5B
85 - 264	12	3	5.42	5	6	8	-12	0.6	65	89	MUI65-5S-12B
85 - 264	12	3	5.42	3.3	6	8	5	0.6	65	89	MUI65-12S33S5SB
85 - 264	12	3	5.42	3.3	6	8	-12	0.6	65	88.5	MUI65-33S-12B
85 - 264	15	2.4	4.34	5	6	8	-15	0.6	65	89.5	MUI65-5S-15B
85 - 264	24	1.5	2.71	5	6	8	12	0.6	65	88.5	MUI40-24S5S12SB
85 - 264	24	1.5	2.71	5	6	8	-12	0.6	65	88.5	MUI65-24S5SN12SB

\* MUIO: Open Type      MUID: Din Rail      Class B Protection Type: Use Suffix "B"  
 MUIT: Chassis Type      MUI: Enclosed (Standard)      Class A Protection Type: No Suffix

## MUI65 DUAL AND TRIPLE OUTPUT

Input Specifications			Output Specifications		
Input voltage range	85 Min., 264 Max., Vac	AC input	Output power, Watt	50 Max.	Pout1+Pout2+Pout3, Vout1, 5V
	120 Min., 370 Max., Vdc	DC input	65 Max.		Others
Input frequency, Hz	47 Min., 63 Max.	AC input	Initial set voltage accuracy, %	-1 Min., 1 Max.	230Vac and Full Load, Vout 1
			-2 Min., 2 Max.		Vout 2, Vout 3
Input current, A	1.65 Max.	100Vac	Line regulation, %	-0.2 Min., 0.2 Max.	Low Line to High Line at Full Load
	0.95 Max.	240Vac	Load regulation, %	-0.5 Min., 0.5 Max.	No Load to Full Load, Vout 1
No load input power, Watts	0.15 Typ.	230Vac	-0.7 Min., 0.7 Max.		Vout 3
			-1.5 Min., 1.5 Max.		No Load to Full Load, Vout 2
Leakage current, $\mu$ A	75 Max.	264Vac	-0.7 Min., 0.7 Max.		0.1W Load to Full Load, Vout 2
			Cross regulation, %	-1.5 Min., 1.5 Max.	Asymmetrical load 25%/100% FL
Start-up time, ms	1000 Max.		Voltage adjustability, %	-10 Min., 10 Max.	Vout 1
			Minimum load, %	0 Typ.	
Rise time, ms	20 Typ.		0.5 Typ.		Vout 3 is full load, Vout 1 + Vout 2
					Measured by 20MHz bandwidth
Hold-up time, ms	16 Typ.	115Vac and full load	100 Typ.		With a 10 $\mu$ F/25V 1206 X7R MLCC, Vout 1, 5V
			120 Typ.		With a 1 $\mu$ F/50V 1206 X7R MLCC, Vout 1, 12V
Input inrush current, A	60 Max.	230Vac	150 Typ.		With a 1 $\mu$ F/50V 1206 X7R MLCC, Vout 1, 15V
			240 Typ.		With a 1 $\mu$ F/50V 1206 X7R MLCC, Vout 1, 24V
Input protection	T3.15A/250Vac	Internal fuse in line and neutral	280 Typ.		With a 1 $\mu$ F/50V 1206 X7R MLCC, Vout 1, 28V
			100 Typ.		With a 10 $\mu$ F/25V 1206 X7R MLCC, Vout 2, All
			100 Typ.		With a 10 $\mu$ F/25V 1206 X7R MLCC, Vout 3, 5V
			120 Typ.		With a 10 $\mu$ F/25V 1206 X7R MLCC, Vout 3, 12V
			150 Typ.		With a 10 $\mu$ F/25V 1206 X7R MLCC, Vout 3, 15V
			Temperature coefficient, %/°C	-0.02 Min., 0.02 Max.	
			Transient response peak deviation, %	3Vout, Max.	Load step from 50-75% change at 2.5A/ $\mu$ s, Vout 1
			Transient response recovery time, $\mu$ s	600, Typ.	
			Over voltage protection, %	125 Min., 140 Max.	% of Vout(nom); Latch mode, Vout 1
			Over power protection, %	145 Typ.	% of nominal output power; Hiccup mode, Pout 1 + Pout 2
			Short circuit protection	Continuous, automatic recovery	

General Specifications			
Isolation voltage, Vac	1 minute (2MOPP insulation)	Input to Output	4000 Min.
		Input (Output) to F.G.	2500 Min.
Isolation resistance, G $\Omega$	500Vdc		0.1 Min.
Switching frequency, kHz	230Vac	Vout 1, 5V	60 Typ.
		Others	115 Typ.
		Vout 2	750 Typ.
		Vout 3	510 Typ.

Environmental Specifications			
Operating ambient temperature, °C	Natural convection, with derating	-40 Min.	85 Max.
Storage temperature range, °C		-40 Min.	85 Max.
Operating altitude, m			5000 Max.
Shock		IEC60068-2-27	
Vibration		IEC60068-2-6	
Relative humidity	Non-condensing	5% to 95% RH	

## MUI65 DUAL AND TRIPLE OUTPUT

Physical Specifications			EMC Specifications						
Design meet safety standard	ANSI/AAMI, ES60601-1, IEC60601-1, EN60601-1		Specifications	Conditions		Level			
Weight, g	155 (5.47oz)	MUIO	EMI <sup>(1)</sup>	EN55011, EN55022 and FCC Part 18	Conducted	Class B			
					Radiated	Class B			
	203 (7.16oz)	MUIT	Harmonic currents	EN61000-3-2	Full load	Class A			
			Voltage flicker	EN61000-3-3					
			ESD	EN61000-4-2	Air ±15kV and Contact ±8kV	Perf. Criteria A			
221 (7.80oz)	MUI	Radiated immunity	EN61000-4-3	20V/m	Perf. Criteria A				
		Fast transient	EN61000-4-4	±2kV	Perf. Criteria A				
		Surge	EN61000-4-5	DM ±1kV	Perf. Criteria A				
		Conducted immunity	EN61000-4-6	20 Vr.m.s	Perf. Criteria A				
243 (8.57oz)	MUID	Power frequency magnetic field	EN61000-4-8	30 A/M	Perf. Criteria A				
						Dip and interruptions	EN60601-1-2	0% of 240 Vac, 0.5 cycle	Perf. Criteria A
								0% of 240 Vac, 1 cycle	Perf. Criteria A
								70% of 240 Vac, 25/30 cycle	Perf. Criteria A
0% of 240 Vac, Single phase	Perf. Criteria B								
Dimensions	2" × 3.5" (50.8 mm × 88.9 mm)		EN61000-4-11	0% of 100 Vac, 0.5 cycle	Perf. Criteria A				
				0% of 100 Vac, 1 cycle	Perf. Criteria B				
MTBF	1.059 × 10 <sup>6</sup> hrs, MIL-HDBK-217F, Full load			70% of 100 Vac, 25/30 cycle	Perf. Criteria A				
				0% of 100 Vac, Single phase	Perf. Criteria B				

**Note:**

1. External components may be required for Class I application. For further information, please contact Polytron Devices, Inc.

**CAUTION:** This power module is not internally fused. An input line fuse must always be used.

### Characteristic Curve

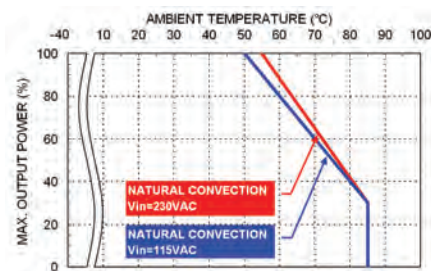

Derating Curve vs. Ambient Temperature

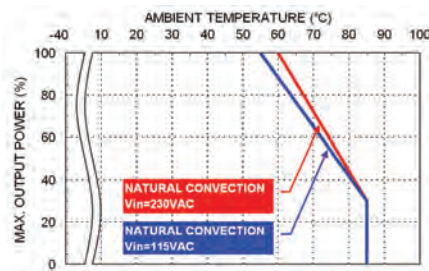

Derating Curve vs. Ambient Temperature

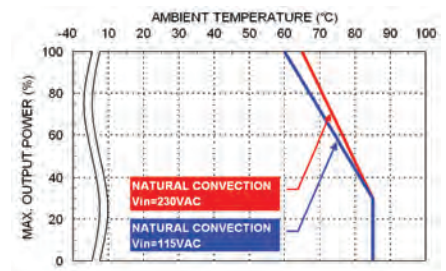

Derating Curve vs. Ambient Temperature

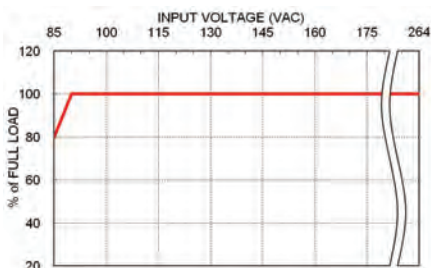

Derating Curve vs. Input Voltage

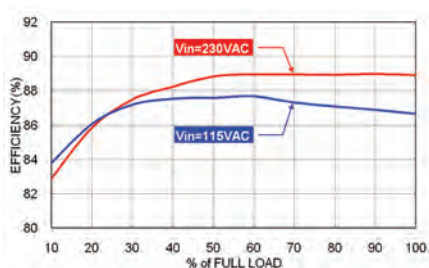

Efficiency vs. Output Load

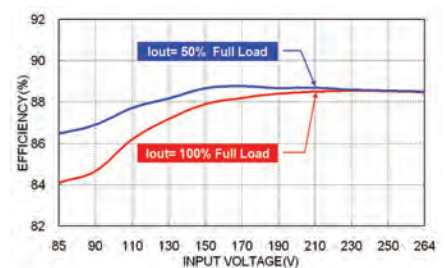

Efficiency vs. Input Voltage

## MUI65 DUAL AND TRIPLE OUTPUT

### Pin Connectors

#### CON1: INPUT CONNECTOR

PIN	
1	Line
3	Neutral

#### MATES WITH

JST Housing	VHR-3N
JST Crimp Terminals	SVH-21T-P1.1

#### Note:

1. Either one of four screws holes of Open/ Chassis Type can be considered as PE connection for Class I application.

#### CON2: OUTPUT CONNECTOR

PIN	
1	Vout 3
2, 3	Com
4, 5	Vout 2
6	Vout 1

#### MATES WITH

JST Housing	VHR-4N
JST Crimp Terminals	SVH-21T-P1.1

### Mechanical Drawing

#### Open Type

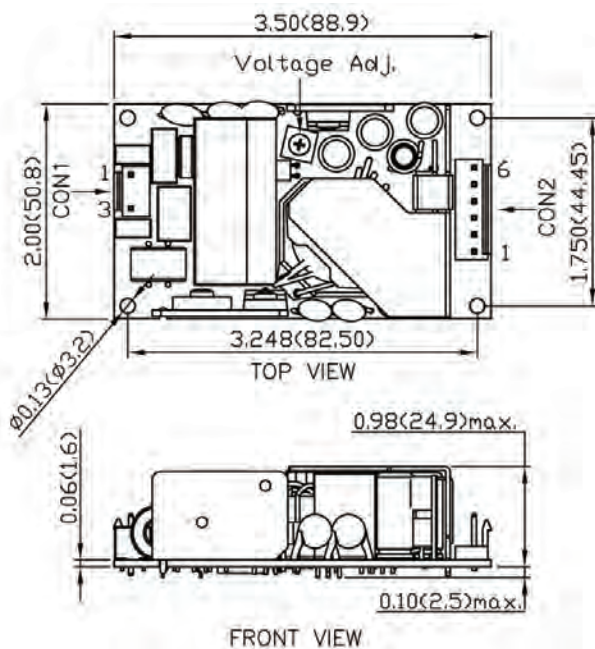

#### DIN Rail Type

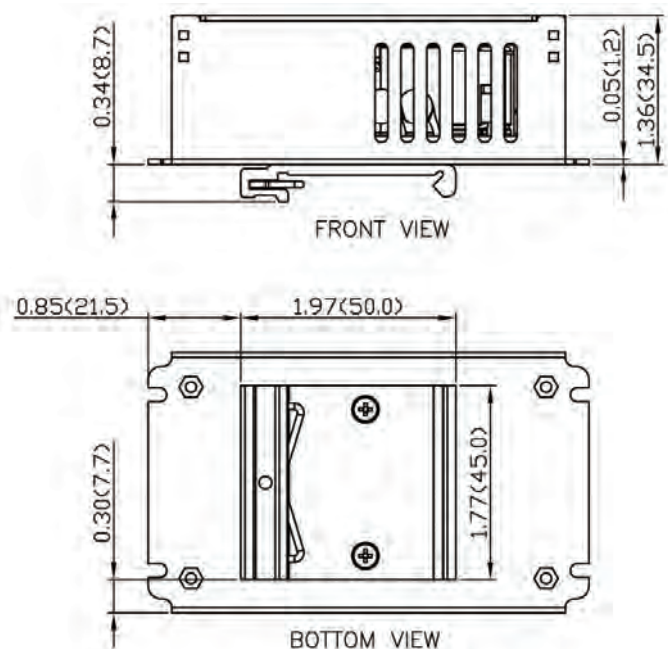

1. All dimensions in inch (mm)
2. Tolerance :x.xx±0.02 (x.x±0.5)  
x.xxx±0.01 (x.xx±0.25)
3. M3 x 0.5 screw locked torque MAX 5Kgf.cm/0.49N.m

# MUI65 DUAL AND TRIPLE OUTPUT

## Mechanical Drawing

### Enclosed Type

### U Chassis Type

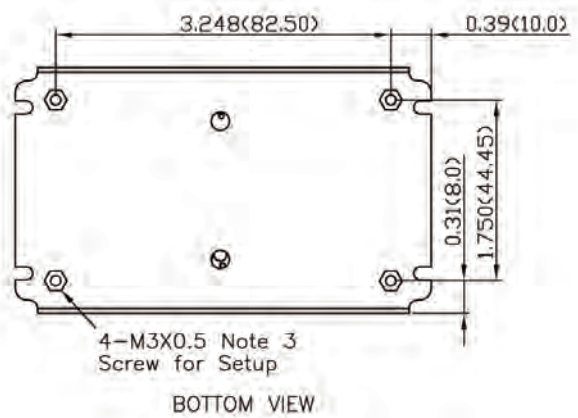
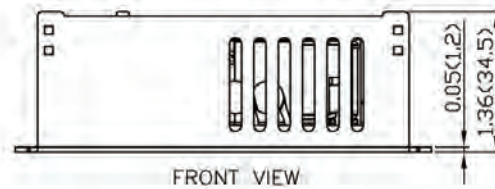
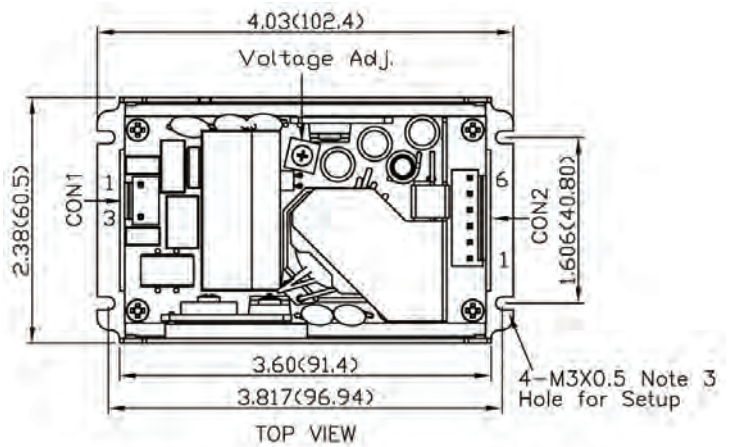
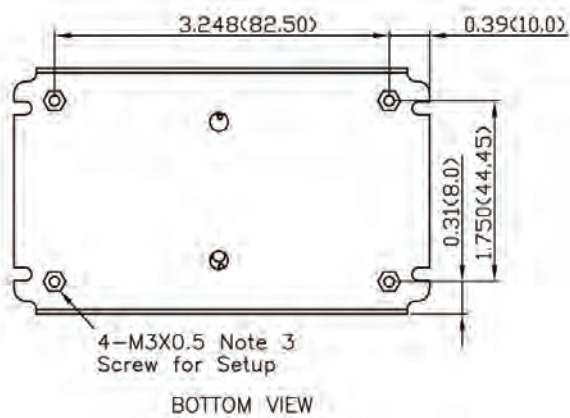
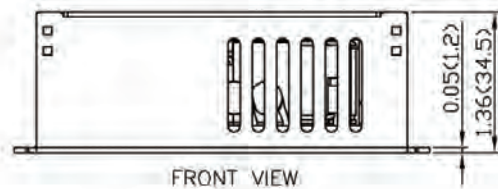
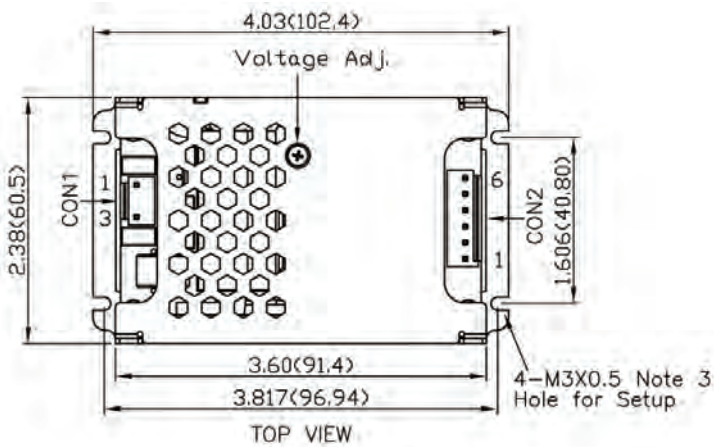

1. All dimensions in inch (mm)
2. Tolerance :x.xx±0.02 (x.x±0.5)  
x.xxx±0.01 (x.xx±0.25)
3. M3 x 0.5 screw locked torque MAX 5Kgf.cm/0.49N.m